

sensor 505-D

User manual



Thank you for purchasing this AgfaPhoto digital camera. Please read these operating instructions carefully in order to use the digital camera correctly. Keep the instructions in a safe place after reading so that you can refer to them later.

Notice: This User's Manual has been written for the following camera models:

AgfaPhoto sensor 500-D, AgfaPhoto sensor 505-D and AgfaPhoto sensor 510-D.

Precautions

Before using the camera, please ensure that you read and understand the safety precautions described below. Always ensure that the camera is operated correctly.

- Do not point the camera directly into the sun or other intense light sources which could damage your eyesight.
- Do not try to open the case of the camera or attempt to modify this camera in any way. High-voltage internal components create the risk of electric shock when exposed. Maintenance and repairs should be carried out only by authorized service providers.
- Do not fire the flash too close to the eyes of animals or people, especially young children. Eye damage may result. In particular, keep at least one meter away from infants when using the flash.
- Keep the camera away from water and other liquids. Do not use the camera with wet hands. Never use the camera in the rain or snow. Moisture creates the danger of electric shock.
- Keep the camera and its accessories out of the reach of children and animals to prevent accidents or damage to the camera.
- If you notice smoke or a strange odor coming from the camera, turn the power off immediately. Take the camera to the nearest authorized service center for repair. Never attempt to repair the camera on your own.
- Use only the recommended power accessories. Use of power sources not expressly recommended for this equipment may lead to overheating, distortion of the equipment, fire, electrical shock or other hazards.

Disclaimer

We assume no responsibility over and above the provisions of the Product Liability Law for damages suffered by the user or third parties as a result of inappropriate handling of the product or its accessories, or by their operational failure and by their use. We reserve the right to make changes to this product and its accessories without prior notice.

Warning! Never open the camera or remove any parts of it. This will void all guarantee claims.

Using your batteries

For best performance and prolonged battery life, we recommend the use of AAA-sized rechargeable NiMH batteries.

Extending battery life

The following functions use up a great deal of battery power and should therefore only be used occasionally:

- Excessive use of flash
- Editing images on the camera display

The battery life can be affected by soiling. Please clean the contacts with a clean, dry cloth before putting the batteries in the camera. Battery performance drops at temperatures below 5° C (41° F). If you use the camera at low temperatures you should have replacement batteries to hand and ensure they do not get too cold. Please note: you should not dispose of cold and seemingly flat batteries because these batteries may work again at room temperature.

Contents

PRECAUTIONS	I	VIDEO MENU LIST	16
DISCLAIMER	II	SETUP MENU	17
USING YOUR BATTERIES	II		
EXTENDING BATTERY LIFE	II	<u>BASIC RECORDING</u>	19
<u>CONTENTS</u>	<u>III</u>		
<u>GETTING STARTED</u>	<u>1</u>	RECORDING STILL IMAGES	19
		SELECTING THE RESOLUTION AND QUALITY	20
USING THIS MANUAL	1	USING THE ZOOM FUNCTION	21
PACKAGE CONTENTS	2	USING THE FLASH	22
PARTS OF THE CAMERA	3	USING THE SELFTIMER	23
ATTACHING THE STRAP	5	USING THE BURST-SNAPSHOT	24
INSERTING THE BATTERIES	5	RECORDING MOVIE CLIPS	25
LOW BATTERY INDICATOR	6	SETTING THE MOVIE SIZE	25
INSERTING A MEMORY CARD	6	RECORDING AUDIO	26
ABOUT CAMERA MEMORY	7	PLAYING BACK AUDIO	26
TURNING POWER ON & OFF	7	<u>OTHER RECORDING FUNCTIONS</u>	<u>27</u>
POWER SAVING FUNCTION	7		
SETTING THE DISPLAY LANGUAGE / DATE & TIME	8	SETTING THE WHITE BALANCE	27
SETTING DISPLAY LANGUAGE	8	SETTING THE COLOR EFFECT	28
SETTING DATE & TIME	9	SETTING THE EXPOSURE	28
USING THE LCD MONITOR	9	SETTING DATE STAMP	29
CAPTURE MODE	10	<u>PLAYBACK</u>	<u>30</u>
VIDEO MODE	11		
PLAYBACK MODE	12	PLAYING BACK IMAGES	30
<u>BASIC OPERATION</u>	<u>13</u>	PLAYING BACK MOVIE CLIPS	30
		USING THE MENU IN PLAYBACK MODE	31
TURNING POWER ON & OFF	13	USING THE MENU IN PLAYBACK MODE	31
CHANGING THE MODE	13	VIEWING THUMBNAILS	32
SWITCHING BETWEEN REC AND PLAYBACK MODE	13	PLAYING A SLIDE SHOW	32
SELECTING THE REC MODE	14	DELETING FILES	33
USING THE MENU IN REC MODE	15	DELETING A SINGLE FILE	33
CAPTURE MENU LIST	16	DELETING ALL FILES	34
		FORMATTING THE SD CARD OR INTERNAL MEMORY	34

PROTECTING FILES	35
CHOOSING A STARTUP IMAGE	36
SETTING THE LOGO	36
EDITING IMAGES	37
ROTATING STILL IMAGES	37
PRINTING	38
<u>MAKING CONNECTIONS</u>	<u>39</u>
CONNECTING THE CAMERA TO A TV	39
CONNECTING THE CAMERA TO A PC	40
USING A CARD READER (NOT INCLUDED)	40
CONNECTING THE CAMERA TO A PC WITH THE USB CABLE	40
<u>SYSTEM REQUIREMENTS</u>	<u>41</u>
<u>APPENDIX</u>	<u>42</u>
ABOUT THE FOLDER & FILE NAMES	42
FOLDER STRUCTURE	42
NAMING FILES	42
TROUBLESHOOTING	43
SPECIFICATIONS	44
CUSTOMER CARE	46
DISPOSAL OF WASTE EQUIPMENT BY USERS IN PRIVATE HOUSEHOLDS IN THE EUROPEAN UNION	47
FCC COMPLIANCE AND ADVISORY	47

Getting Started

Using This Manual

Getting Started

This section contains information you should know prior to using this camera.

Basic Operation

This section explains all recording features of the camera.

Basic Recording

This section explains how to record still images, movies and audio files.

Other Recording Functions

This section explains common operations when recording images.

Playback

This section explains playback, delete and edit functions of still images, movies and audio files.





Making Connections

This section explains how to connect the camera to a computer or TV.

Appendix

This section provides troubleshooting and the camera specifications.

The meanings of the symbols used in this user's manual are explained below:

 Caution 	This indicates warnings that should be read before using these functions.
 Tips 	This indicates useful information for the use of this camera.
	This indicates the reference page.

Package Contents

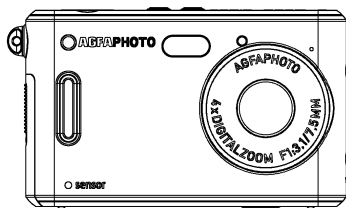

AgfaPhoto sensor

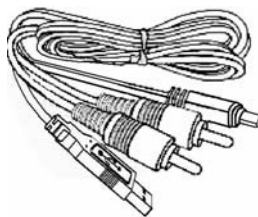

USB / AV cable

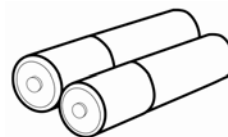

2 x AAA batteries

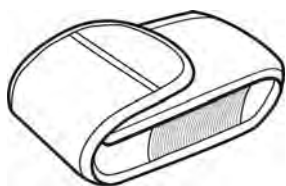

Pouch



Strap

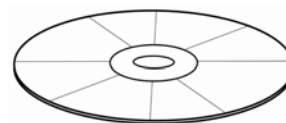

Software Installation
CD-ROM

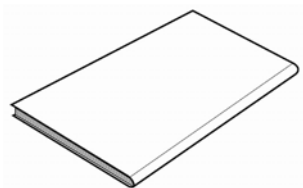

Quick guide

Parts of the Camera

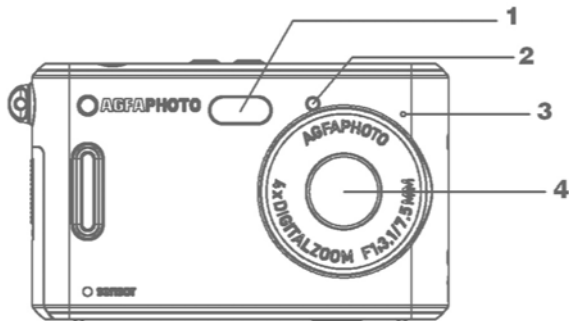

- 1. Flash
- 2. Self-timer lamp
- 3. Microphone
- 4. Lens

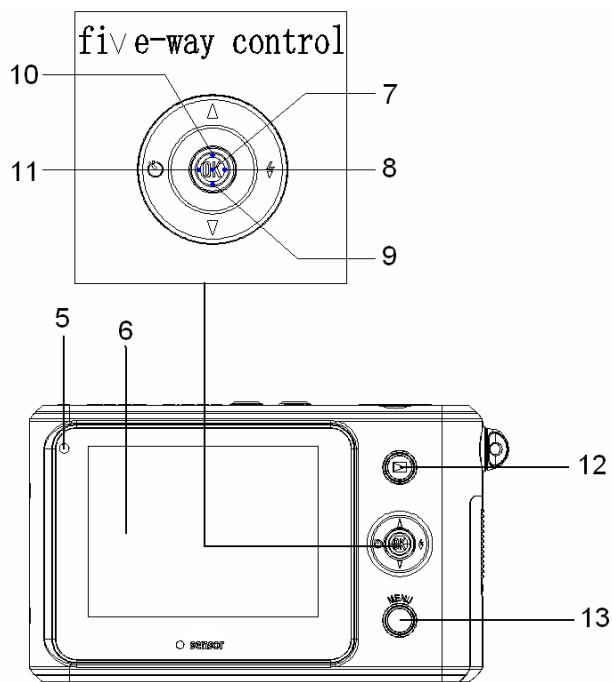

- 5. Operation lamp
- 6. LCD display
- Five-way control button**
- 7. Vertically (OK)
- 8. Rightward 
- 9. Downward 
- 10. Upward 
- 11. Leftward 
- 12. Playback button
- 13. Menu button

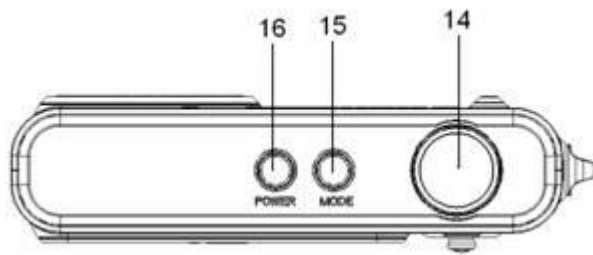

- 4. Shutter button
- 15. Mode button
- 16. Power button

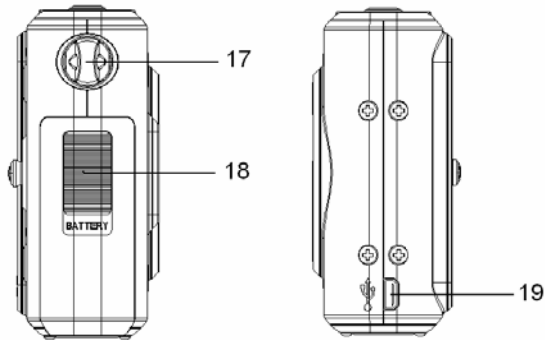

- 17. Strap mount
- 18. Battery cover
- 19. USB jack

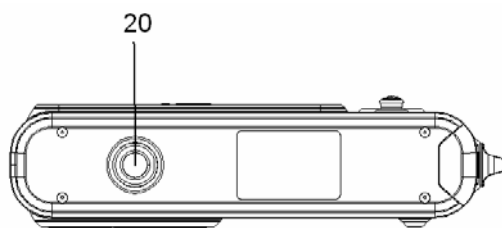

- 20. Tripod socket

Attaching the Strap

Attach the strap to your camera as shown in the image.

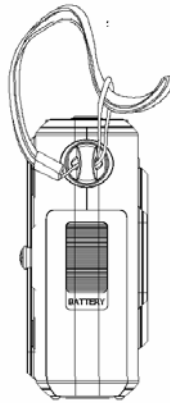

! Caution

- Do not swing the camera around by the strap

Inserting the Batteries

The camera is powered by two AAA-size alkaline batteries or rechargeable NiMH batteries.

- 1 Open the battery cover.**
Slide the battery cover in the direction indicated by the arrows.

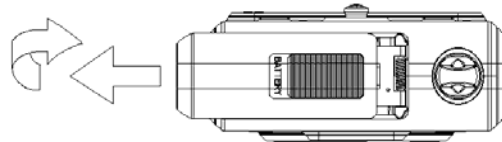

- 2 Insert the batteries.**
Insert two AAA-size batteries with the positive (+) and negative (-) poles matching the directions indicated inside the battery compartment.

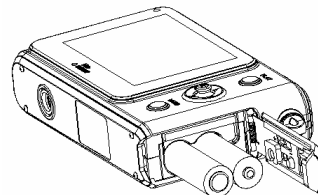

- 3 Close the battery cover.**

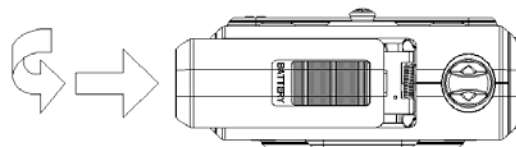

Low Battery Indicator

A low battery indicator  appears on the LCD screen when the batteries are nearly exhausted. Batteries should be replaced promptly when the low battery indicator appears.

Caution

- There is a risk of explosion if the battery is replaced by an incorrect type. Dispose of used batteries according to instructions.
- Be sure to turn off the camera power before inserting or removing batteries.
- Use only Alkaline or NiMH batteries to power this camera. Use of any other type of battery is not recommended.
- Replace all batteries at the same time. Never mix old and new batteries.
- Remove batteries if you will not be using the camera for a long time.
- The camera body may feel warm after extended use. This is normal.

Inserting a Memory Card

You can use an SD card with this digital camera. The memory card slot is adjacent to the battery compartment.

- 1**
Open the battery cover.
Slide the battery cover in the direction indicated by the arrows.

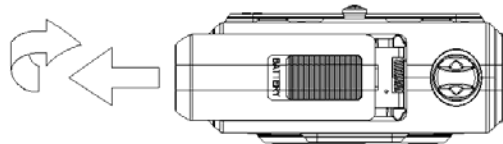

- 2**
Insert the card.
Insert the card with the label facing up and the arrow pointing inwards.

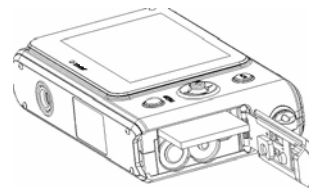

Tips

- To remove the card, gently press on the edge of the card to release it. Pull the card out and close the battery cover.

- 3**
Close the battery cover.

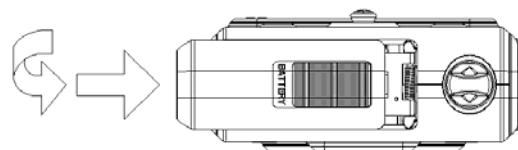

! Caution

- If you insert or remove the card while the camera is powered on, it may damage the card or data.
- Do not touch the connection terminals on the back of the card.

About Camera Memory

This camera is equipped with an internal memory. If a memory card is not inserted in the camera, all images and movie clips recorded by the camera will be stored in the internal memory. If a memory card is inserted, images and movie clips will be stored on the memory card.

Turning Power On & Off

1

Press the Power button (1) to turn on the camera in the Capture mode. The power turns on and the LED (2) lights red.

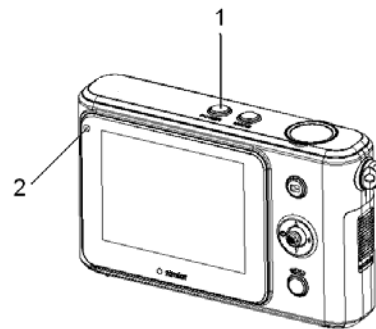

2

Press the Power button (1) again to turn the power off. The power turns off and the LED turns off.

?

Tips

- You can turn on the camera without the startup and operating sound by setting the function **[Play Logo]** and **[Buzzer]**.
- Switch between Capture mode and Playback mode (👉 **page 13**).

Power Saving Function

To save battery power, the LCD monitor automatically turns off 30 seconds after the last control accessed (factory-preset setting). Press any button other than the power button to turn on the LCD monitor. After the power saving function has been active for the set time, the power will turn off completely. Press the power button to power the camera back on. You can change the power-off timeout by setting the function [auto power off time] in the Setup menu.

! Caution

The power saving feature will not activate in the following situations:

- When recording movie clips or audio files
- When playing movie clips or audio files
- When playing the slideshow
- When connecting the camera to a computer or printer with the USB cable

Setting the Display Language / Date & Time

When using the camera for the first time after purchasing it, be sure to choose a language and set the date & time before using the camera.

Setting Display Language

1 Turn the power on, and set the camera to the Setup Menu (👉 page 17).

2 Select [Language].
Press ▲ or ▼ to select [Language] then press ▶ to launch the submenu.



3 Select a language.
Press ▲ or ▼ on the five-way control button to select a language and press **OK/Enter button** to apply the setting.

4 Press the **MENU button** to close the menu.

Setting Date & Time

1

Turn the power on, and set the camera to the Setup Menu (👉 page 17).

2

Select [Date/Time].

Press ▲ or ▼ on the five-way control button to select [Date/Time] and then press ▶ on the five-way control button to launch the submenu.

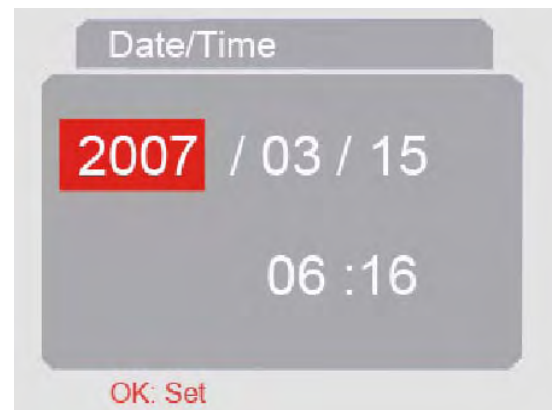

3

Set date and time.

Press ▲ or ▼ on the five-way control button to change the highlighted value. Press ▶ on the five-way control button to move the cursor between settings.

?

Tips

- Holding down ▲ or ▼ changes the values continuously. For date stamp setting (👉 page 29).

4

Apply the setting.

After adjusting the settings, press **OK/Enter** to apply the setting. Finally press the MENU button to close the setup menu.

Using the LCD Monitor

The LCD monitor is used to compose images while recording, adjust settings and play back images. The following indicators may appear on the LCD monitor while recording or playing back images.

Capture Mode

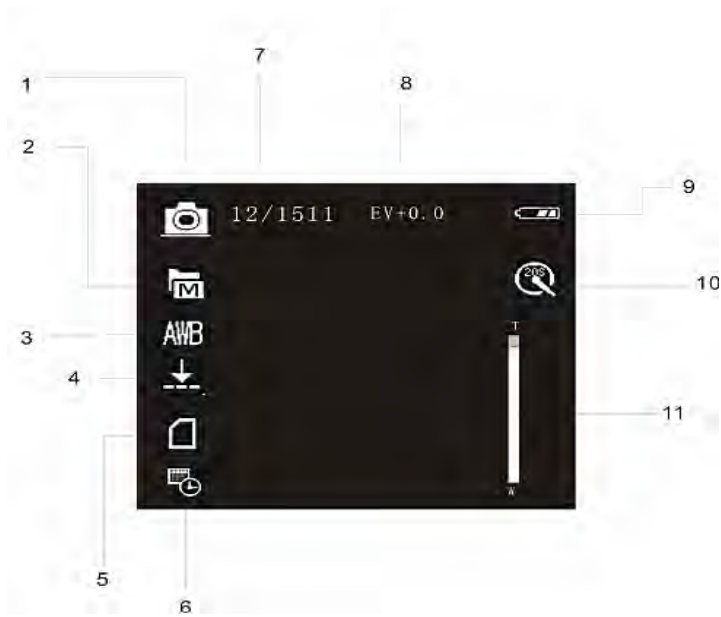



1 Capture mode

2 Resolution indicator

 2592 x 1944

 2048 x 1536

 1600 x 1200

 1280 x 960

 640 x 480

3 White balance indicator:

 Cloudy

 Daylight

 Fluorescent

 Tungsten

 Auto

4 Quality indicator:

 Super

 Fine

 Normal

5 Memory card inserted

6 Date stamp



7 Images taken/image capacity

8 EV value

-2.0EV-----2.0EV

9 Battery level indicator:

10 Selftimer indicator:

-  Empty
-  Half
-  Full

 20 seconds

 10 seconds

11 Digital zoom bar

Video Mode



1 Video mode

2 Resolution indicator:

 640 x 480

 320 x 240

3 White balance indicator:

 Cloudy

 Daylight

 Fluorescent

 Tungsten

 Auto

4 Memory card inserted

5 Recording time

6 Battery level indicator:

 Empty

 Half

 Full

7 Digital zoom bar

Playback Mode



1 Playback mode:

WAV Audio file

AVI Video file

▶ Still image

3 Number of current file/total number
of recorded files

2 Protect indicator

4 Battery level indicator:

 Empty

 Half

 Full

Basic Operation

Turning Power On & Off

- 1 Press the Power button (1) to turn on the camera in the Capture mode. The power turns on and the LED (2) lights red.

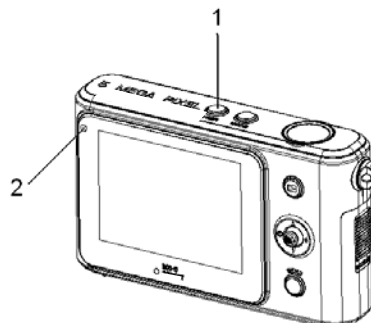

- 2 Press the Power button (1) again to turn the power off. The power turns off and the LED turns off.

? Tips

- You can turn on the camera without the startup and operating sound by setting the function [Play Logo] and [Buzzer].
- Switch between Capture mode and Playback mode (👉 page 13).

Changing the Mode

You can record images and voices in the **REC mode** and use the **Playback** mode to replay, delete or edit images on the LCD monitor.

Switching between REC and Playback Mode

In **REC mode**, press the Playback button (2) to switch to the **Playback mode**.

In **Playback mode**, press the Playback button (2) to switch to the **REC mode**.

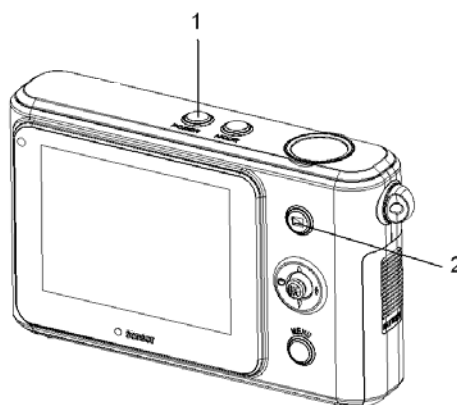

Selecting the REC Mode

1



Press the Power button to enter the Capture mode.

If the camera is in Playback mode, press the Playback button to change to REC mode.

2

Press the Mode button (1) to change the REC mode.

Each time the Mode button is pressed the REC mode icon changes. It includes three modes in REC mode: Capture mode, Video mode and Audio mode.

Display	Title	Description
	Capture mode	For taking still photos.
	Video mode	For recording movie clips.
	Audio mode	For recording audio files.



Caution

- The Mode button will not work when the camera is in Playback mode.

Using the Menu in REC Mode

When a menu is displayed, the five-way control button is used to make the desired settings. The Audio mode does not have a menu so the MENU button will not work in Audio mode.

1

Capture menu.

Turn the power on, and set the camera to the Capture mode (👉 [page 13](#)).

2

Open the Capture menu.

Press the MENU button (2) to display the menu.

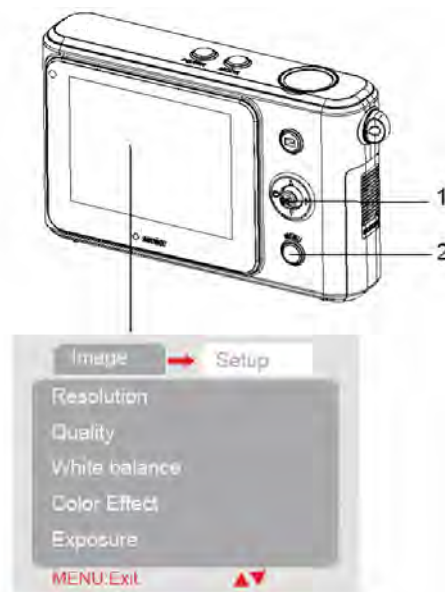

3

Select an item.

Press ▲ or ▼ on the five-way control button (1) to select an item.

4

















Change the setting.

Press ▢ on the five-way control button (1) to launch the submenu. Press ▲ or ▼ on the five-way control button (1) to change the setting.

5







Press OK/Enter on the five-way control button (1) to save the settings and finally press the MENU button (2) to close the menu

Capture Menu List

Menu item	Available settings
Resolution	 /  /  /  / 
Quality	 /  / 
White balance	 /  /  /  / 
Color effect	Color / Sepia / Monochrome
Exposure	-2.0EV-----2.0EV
Date stamp	Enable  / Disable
Selftimer	Disable / 10 sec.  / 20 sec. 
Burst-Snapshot	Single/ Burst 

Video Menu List

Set the camera in Video mode then press the MENU button to display the menu.

Menu item	Available settings
Resolution	 640 x 480/  320 x 240
Frame rate	30 fps / 15 fps
White balance	 /  /  /  / 
Audio	Enable / Disable

Setup Menu

1 Turn the power on and set the camera to the REC or Playback mode (☞ page 13).

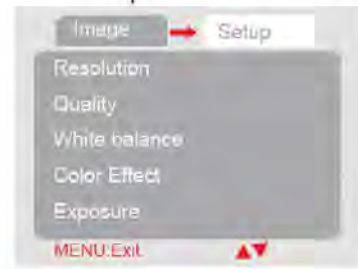
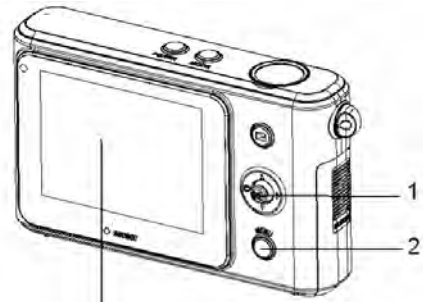

2 Press the MENU button (2) to open the REC or Playback menu. The menu displayed depends on whether you are in the REC mode or the Playback mode.





3 Open the Setup menu.

Press  on the five-way control button (1) to select **[Setup]** to display the Setup menu.

4 Select an item.

Press  or  on the five-way control button (1) to select a menu item then press  on the five-way control button (1) to launch the submenu.

5 Change the setting.

Press  or  on the five-way control button (1) to select an option and press OK/Enter (1) to apply the setting.

6 Press the MENU button (2) to close the menu.

Menu item	Function
Language	Select a language for the Display menu and other information from the following languages: [English] : English, [Italiano] : Italian, [Français] : French, [Nederlands] : Dutch, [Čestina] : Czech, [Русский] : Russian, [Türk] : Turkish, [Deutsch] : German, [Español] : Spanish, [Português] : Portuguese, [Magyar] : Hungarian, [Polski] : Polish, [Ελληνικά] : Greek, [体中文] : S. Chinese , [日本語] Japanese
Auto power off	To save power, the camera is turned off automatically after a period of time. There are three options: [Disable] / [60Sec] / [120Sec].
TV output	You can review images on a television with the supplied AV cable. TV Out should be set to either NTSC or PAL depending on your region. [NTSC]: America, Japan and others; [PAL]: Europe, Oceania and others.
Play logo	Use this function to turn the startup image on or off. [Enable] / [Disable]
Light frequency	Light Frequency should be set to either 60Hz or 50Hz depending on your region. [50HZ] / [60HZ].
Date / Time	To record the shooting date and time.
Buzzer	Sets the operation sound on and off. [Enable] / [Disable]
Format	To erase all data stored on the memory card if you are using a memory card, or all data stored in the internal memory if there is no card inserted. All data will be deleted including protected files. Be sure to download important files to your computer before formatting. [Yes] / [No].
Default settings	To reset the entire menu and button operation settings to initial default. The Date & Time settings do not change after reset all.
USB mode	You can use this camera as a PC camera or removable disk. [PC Camera]: Use as a PC camera; [Mass storage]: Use as a removable disk.

Basic Recording

Recording Still Images

1

Turn the power on, and set the camera to the Capture mode. (👉 page 13).

2

Compose the subject on the monitor.

Point the center area of the LCD screen at the subject that you want to take a photo of.

3

Take the picture.

Press the shutter button fully down to take the picture.

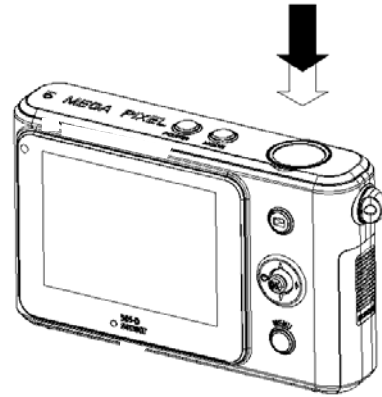

! Caution

- Make sure that your fingers or the wrist strap do not cover the lens.
- Do not take the memory card or battery out when the camera is saving the image, otherwise the image will not be saved completely

Selecting the Resolution and Quality

You can select a lower image resolution and quality to decrease the image size in order to capture more images. Choose a suitable setting according to the desired image quality and purpose.







Image size AgfaPhoto sensor 505-D		Picture size	
	2592 x 1944	Printing larger than A4 size Printing to postcard or attaching to E-mail	Larger  Smaller
	2048 x 1536		
	1600 x 1200		
	1280 x 960		
	640 x 480		













Image size AgfaPhoto sensor 510-D		Picture size	
	3264 x 2448	Printing larger than A4 size Printing to postcard or attaching to E-mail	Larger  Smaller
	2592 x 1944		
	2048 x 1536		
	1600 x 1200		
	640 x 480		

Image size AgfaPhoto sensor 500-D		Picture size	
	2592 x 1944	Printing larger than A4 size Printing to postcard or attaching to E-mail	Larger  Smaller
	2048 x 1536		
	1600 x 1200		
	1280 x 960		
	640 x 480		

Caution

The resolution and quality will affect the required storage space of the images.

Compression		Purpose	
	Super	To shoot higher quality images.	Higher Quality ↑ Lower Quality
	Fine	To shoot normal quality images.	
	Normal	To shoot images.	

Using the Zoom Function

Your camera has a digital zoom function that allows you to zoom in or zoom out on subjects. The digital zoom enlarges or shrinks the image using a software process.

- 1
Make the zoom setting, and point the camera at the subject.
- 2
Press or on the five-way control button (1) to compose the image.
[W]: zoom out for a wide-angle shot.
[T]: zoom in for a telephoto shot.
 - When the zoom button is pressed, the zoom bar appears on the LCD monitor.
- 3
Press the shutter button to take a picture.

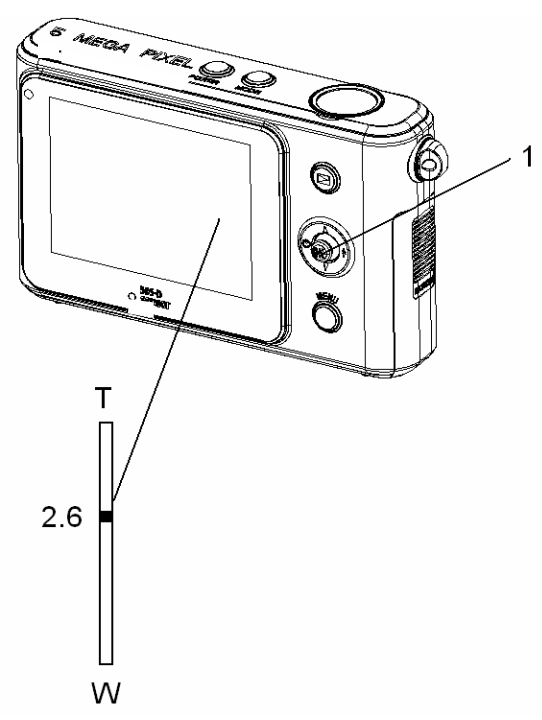

? Tips

- The digital zoom works by enlarging the center portion of an image through a software interpolation process.
- The digital zoom is used to achieve magnification levels up to approx. 4 times.
- The higher the digital zoom, the lower the image quality.

Using the Flash

The flash is not only for taking pictures when there is insufficient light, but also for when the subject is in shade or with backlight conditions. Pressing the flash button cycles your camera through the various flash modes. The flash will not activate during continuous shooting or movie recording.

1 Turn the power on and set the camera to the Capture mode (☞ page 13).

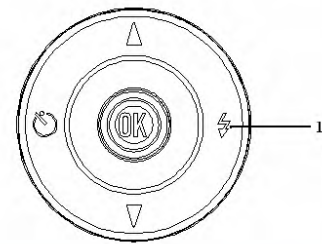

2 Press  on the five-way control button (1) to change the flash mode.

- Each time the flash button is pressed, the flash icon (2) changes.



Auto flash:

Flash fires automatically when shooting conditions require extra lighting.



Full Flash:

Flash fires every time you take a photo, regardless of lighting conditions.



Flash OFF:

The flash never fires even in dark conditions.



3 Press shutter button to take a picture.

 **Caution**

- The flash charging time may increase when the battery is low.
- The screen is blank when the flash is charging. The next image can be shot only when charging is completed.
- Shooting with a flash in a bright environment may cause incorrect exposure.



Using the Selftimer

Use the selftimer to set a delay from the time the shutter button is pressed to the time the image is shot. Use Burst to record continuous still image shooting.

1
Turn the power on, and set the camera to the Capture mode ( page 13).

2
Open the REC menu ( page 15).

3
Change the setting.

Press Mode button to launch the submenu. Press  or  to select [**Selftimer**], then press OK/Enter to confirm the setting.

Disable: Do not use Selftimer.



10 sec.:

The shutter release will delay for 10 seconds.



20 sec.

The shutter release will delay for 20 seconds.

4
Press the MENU button to close the menu list. Press the shutter button to take a picture.

 **Tips**

- When using the selftimer function, be sure to use a tripod or place the digital camera on a level, stable surface.
- When using the selftimer function the selftimer lamp will blink and turn off after the picture is taken.

Using the Burst-Snapshot

Use this function to take 3 pictures continuously.

1

.....
Turn the power on, and set the camera to the Capture mode (👉 page 13).
.....

2

.....
Open the Capture menu (👉 page 15).
.....

Change the setting

3

Press the Mode button to launch the submenu. Press ▲ or ▼ on the five-way control button to select [**Burst-Snapshot**]. then press OK/Enter to confirm the setting.

Single: Press the shutter button once to take one picture.

Burst: Press the shutter button once to take three pictures continuously.

4

.....
Press the MENU button to close the menu list.

Press the shutter button to take a picture series. When using the Burst-Snapshot function the flash will not work.

Recording Movie Clips

1

.....
Turn the power on, and set the camera to the Video mode (👉 page 13).
.....

2

Compose the subject on the monitor.

- Point the center area of the LCD screen at the subject that you want to take.
-

3

Start recording.

- Press the shutter button to start recording.
 - The LCD monitor displays the recorded time.
 - The white balance is set and locked to the settings of the first frame.
-

4

Finish recording.

- Press the shutter button again to stop recording.
- The camera will stop recording automatically when the memory capacity is full.





Caution

- When the digital zoom function is used in Movie mode the zoom bar will not display.

Setting the Movie Size

Movie size and frame rate

Resolution		Frame rate	
	640 x 480	30 fps / 15 fps	Higher quality ↕ Lower quality
	320 x 240	30 fps / 15fps	

Recording Audio

1 Turn the power on, and set the camera to the Audio mode (☞ page 13).

2 Press the shutter button (1) to start recording.

The voices are recorded via the microphone (2) of the camera. Be careful to avoid touching the microphone while recording.

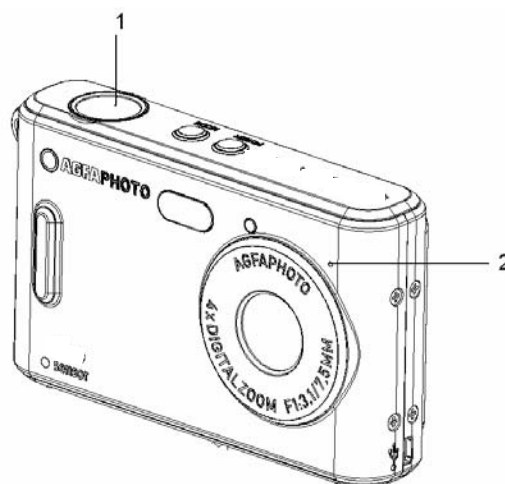

3 Press the shutter button again to end recording.

The camera will stop recording automatically when the memory capacity is full.

! Caution

Please note that this camera has no built-in speaker. Sound is only available when connecting with TV or PC to playback.

Playing Back Audio

1 Turn the power on, and set the camera to the Playback mode (☞ page 13).

2 Press  or  on the five-way control button to select the audio file (WAV).

3 Start playback.

Press the shutter button to start playing the audio file. Press it again to stop the audio file. Press OK/Enter to pause. When the audio playback is paused, press OK/Enter to resume.





! Caution

- Please note that this camera has no built-in speaker. Sound is only available when connecting with TV or PC to playback.

Other Recording Functions

Setting the White Balance

Adjust the white balance to suit different light sources such as sunlight, incandescent (tungsten) lighting or fluorescent lighting.

Option	Description
	Automatically corrects white balance. Ideal for general photography.
	Adjusts for bright sunlight conditions or natural light conditions.
	Adjusts for normal indoor lighting conditions. Corrects the orange hue of household light bulbs. Ideal for indoor photos under tungsten or halogen lighting without a flash.
	Adjusts for fluorescent lighting. Corrects the green hue of fluorescent lighting. Ideal for indoor photos under fluorescent lighting.
	Adjusts for cloudy days or twilight conditions.



Tips

- A practical method of obtaining the proper white balance is by comparing the different white tones resulting from photographing a white sheet of paper with the different manual White Balance settings. From the most realistic white tone obtained you can determine the best White Balance setting under the current lighting conditions.

Setting the Color Effect

Set the color effect to add a color tone to the picture.

Option	Description
Color	Reflects the true color of the object.
Sepia	Adds a sepia color tone to the picture
Monochrome	The pictures only have two colors: white and black.

Setting the Exposure

Set the exposure value manually to compensate for unusual lighting conditions such as indirect indoor lighting, dark backgrounds, and strong backlighting.

- 1 Turn the power on, and set the camera to the **Capture mode** (👉 page 13).

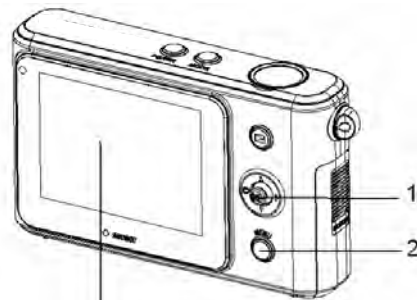

- 2 Open the **Capture menu**. Press the MENU button (2) to display the menu.

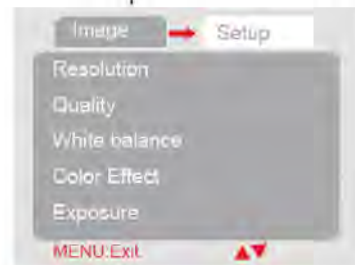

- 3 **Select Exposure.**
Press ▲ or ▼ on the five-way control button (1) to select [Exposure].

- 4 **Change the setting.**
Press ▶ on the five-way control button (1) to launch the submenu. Press ◀ or ▢ on the five-way control button (1) to change the setting.

- 5 **Apply the setting.**
Press OK/Enter on the five-way control button (1) to apply the setting. Press the MENU button to close the menu.

Setting Date Stamp

The date stamp function can be used to add a date to your pictures as you take them.

Option	Description
Enable	Add the recording date & time to printed images.
Disable	Do not add the recording date & time to printed images.

Playback

Playing Back Images

1

.....
Turn the power on, and set the camera to the Playback mode (👉 page 13).

The latest recorded image appears on the LCD display. If there are no images stored, a message [No file] appears.
.....

2

Pressing ◀ or ▶ on the five-way control button displays the previous or next image.

◀ : displays the previous image.

▶ : displays the next image.
.....

Playing Back Movie Clips

1

.....
Turn the power on and set the camera to the Playback mode (👉 page 13).
.....

2

Press ◀ or ▶ on the five-way control button to select a movie clip that you want to play back.
.....

3

Start playing back.

Press the shutter button to start playing the movie clip. Press the shutter button again to stop the movie clip, or press OK/Enter to pause it. When the movie is paused, press the five-way control button again to resume.



Caution

- Please note that this camera has no built-in speaker. Sound is only available when connecting with TV or PC to playback.

Using the Menu in Playback Mode

When a menu is displayed, the five-way control button is used to make the desired settings.

Using the Menu in Playback Mode

1 Turn the power on and set the camera to the Playback mode (👉 page 13).

2 Open the Playback menu.
Press the Menu button (2) to display the menu.

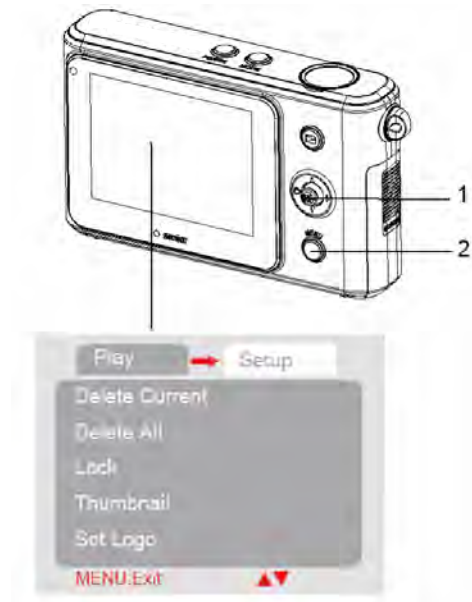

3 Select an item.
Press ▲ or ▼ on the five-way control button (1) to select an item.

4 Change the setting.
Press ▶ on the five-way control button (1) to launch the submenu. Press ▲ or ▼ on the five-way control button (1) to change the setting.

5 Press OK/Enter (1) to save the settings and finally press the Menu button (2) to close the menu.

! Caution

- If the item in the menu list is gray it means this item doesn't work in this file format.

Viewing Thumbnails



1

Turn the power on and set the camera to the Playback mode (👉 page 13).





2

Press  on the five-way control button: a thumbnail screen is displayed. You can also view the thumbnail screen in the following way:



Set the camera to the Playback mode, then press the MENU button to display the menu. Press  on the five-way control button and select **[Thumbnail]**. Finally press  on the five-way control button to view the thumbnail screen.

3

Use  /  /  /  on the five-way control button to select the desired image, and press OK/Enter to show the selected image in full screen.

?

Tips

- You can delete images in thumbnail view see (👉 page 33)



Playing a Slide Show

1

Turn the power on, and set the camera to the Playback mode (👉 page 13).

2

Enter the slide show.

Press the MENU button. Press  /  on the five-way control button to select **[Slide show]** then press  on the five-way control button to start the slide show.

3

End the slide show.

During the slideshow, press OK/Enter to pause and press it again to resume. Press the shutter button to end the slide show

Deleting Files

Deleting a Single File

1

Turn the power on, and set the camera to the Playback mode (👉 page 13).

2

Select the file you want to delete.

When the file is shown in full screen, press ◀ or ▶ on the five-way control button to select the file you want to delete.

3

Open the menu.

Press the MENU button, then press ▼ or ▲ on the five-way control button to select [Delete current].

4

Delete the file.

Press ▶ on the five-way control button to delete the file.



Tips

To quickly delete the current image:

1: Set the file shown in thumbnail mode.

2: Press ▲ / ▼ / ◀ / ▶ on the five-way control button to select the file you want to delete.

3: Press the MENU button to display the dialog “Confirm delete? Yes/ No”.

4: Press ◀ on the five-way control button to select “Yes” then press OK/Enter to delete it.

Deleting All Files

1

Turn the power on, set the camera to Playback mode.

2

Open the menu

Press the MENU button. Then press ▼ or ▲ on the five-way control button to select [Delete all].

3

Delete the files

Press ▶ on the five-way control button to delete the files.

?

Tips

- All the files can be deleted except the protected files.

Formatting the SD Card or Internal Memory

1

Turn the power on and set the camera to any mode except Audio mode.

2

Open the menu.

Press the MENU button, then press ▶ on the five-way control button to select [Setup]. Now press ▼ or ▲ on the five-way control button to select [Format].

3

Formatting the SD card or internal memory.

Press ▶ on the five-way control button to launch the submenu.

Press ▼ or ▲ on the five-way control button to select [Yes] and then press OK/Enter to format .

?

Tips

- Use this function to erase all data stored on the memory card if you are using a card, or all data stored in the internal memory if there is no card inserted.
- Be sure to backup all important files before formatting.

1

Turn the power on and set the camera to the Playback mode (👉 page 13).

2

Select a file to be protected. If you want to protect a single file select it before operating the following steps. Press ◀ or ▶ on the five-way control button to select a recorded file

3

Open the menu.

Press the MENU button, then use the five-way control button to select **[Lock]**.

Press ▶ on the five-way control button to launch the submenu:

- [Lock current]: Protects a single file
- [Lock all]: Protects all files
- [Unlock current]: Unprotects the selected protected file
- [Unlock all]: Unprotects all the protected files

4

Select an item.

Press ▲ or ▼ on the five-way control button to select an item.

5

Apply the setting.

Press OK/Enter to apply the setting.

6

Close the menu.

Press the MENU button to close the menu.

?

Tips

- An icon will be displayed on protected files.
- Protected files cannot be deleted; however if the SD card or internal memory are formatted, the protected files will also be erased.

Choosing a Startup Image

Setting the Logo

1

Turn the power on, and set the camera to the Playback mode.

.....

2

Select a still image as startup image.

Press  or  on the five-way control button to select a still image.

.....

3



Open the menu.

Press the MENU button, then use the five-way control button to select **[Set Logo]** then press  on the five-way control button to launch the submenu: [Yes]; [No].

.....

4

Apply the setting.

Press  or  on the five-way control button to select [Yes] then press OK/Enter to apply the setting.

.....

5

Close the menu.

Press the MENU button to close the menu.





Caution

- The startup image will not be deleted even if the original image is deleted or the memory is formatted.

Editing Images

Rotating Still Images

1
Turn the power on, and set the camera to the Play mode (👉 page 13).

2
Press  or  on the five-way control button to select the image you want to rotate.

3
Open the menu.
Press the MENU button, then use the five-way control button to select [Rotate] and finally press  on the five-way control button to launch the submenu:
[90°]: Rotates the image 90 degrees clockwise
[180°]: Rotates the image 180 degrees clockwise
[270°]: Rotates the image 270 degrees clockwise

4
Select an item.
Press  or  on the five-way control button to select the degrees.

5
Apply the setting.
Press OK/Enter to apply the setting.

6
Close the menu.
Press the MENU button to close the menu.

 **Caution**)



- If the picture size is 5 megapixel or more the rotating function will not work.

Printing

The Digital Print setting allows you to directly print from a camera to a printer by connecting them via a USB cable. Photos can be printed quickly and easily from your digital camera without using a computer

1

.....

Turn the power on, set the camera to the Playback mode and press  or  on the five-way control button to select a still image ( page 13).

2

.....



Open the menu.

Press the MENU button, then use the five-way control button to select **[Print]** and then press  on the five-way control button to launch the submenu.

3

.....

Select an item.

Press  or  on the five-way control button to select **[Yes]**.

4

.....

Confirm the setting.

Press OK/Enter to apply the setting, then a message “Please connect to printer” appears. Connect the camera to a compatible printer with the supplied USB cable.

5

.....

Power on the printer and press OK/Enter: the image is printed. For more information please refer to your printer’s instructions.

Making Connections

Connecting the Camera to a TV

You can display recorded images on a television with the supplied AV cable.

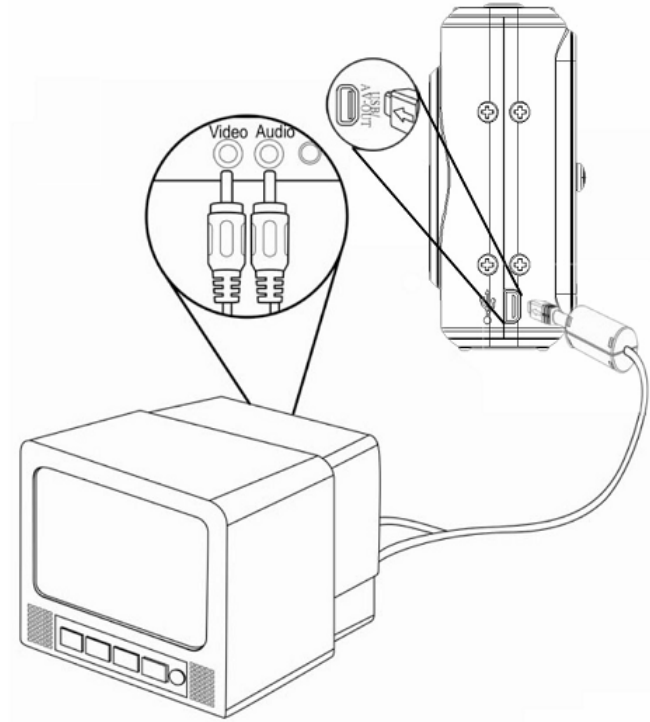

- 1**
Set the TV-out to match the TV system that you are using.
- 2**
Turn off the camera and the TV.
- 3**
Use the supplied AV cable to connect the camera to the TV set.
Then turn on the camera and the TV.
- 4**
Set the TV input signal to Video In.
 - Refer to the documentation included with your TV for more information.
- 5**
Display on TV.
 - Everything that would normally appear on the camera's LCD screen, such as photos and video clip playback, slide shows and image or video capture, will appear on the TV. The camera's LCD screen turns off.

Connecting the Camera to a PC

There are two ways to download files from the camera's internal memory or memory card to a computer:

- By inserting the memory card into a card reader
- By connecting the camera to a computer using the supplied USB cable.

Using a Card Reader (not included)

1
Eject the memory card from the camera and insert it into a card reader that is connected to a computer.

2
Open [My Computer] or [Windows Explorer] and double-click the removable disk icon that represents the memory card.

3
Copy images from the card into a directory of your choice on the computer's hard disk.

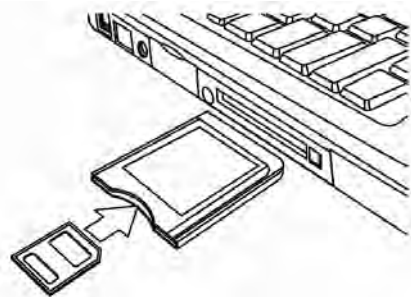

Connecting the Camera to a PC with the USB Cable

1
To download photos from the camera
Connect the supplied USB cable to the computer's USB port and turn on the camera. A message "Mass Storage" or "PC Camera" appears on the screen when connection to the computer has been successfully completed. Press the playback button to switch the camera mode between mass storage and PC camera. To download photos please select "Mass Storage" mode.

2
Open [My Computer] or [Windows Explorer]. A "Removable Disk" appears in the drive list.
Double-click the "Removable Disk" icon to view its contents. Files stored on the camera are located in the folder named "DCIM".

3
Copy the photos or files to your computer.

System Requirements

Windows:

- PC with processor better than MMX Pentium 233 MHz
- Windows XP/ 2000/ Vista32
- Minimum 32 MB RAM
- USB port
- CD-ROM drive
- 800 x 600 pixels, 16-bit color display compatible monitor

*Specifications are subject to change without prior notice.

Appendix

About the Folder & File Names

Your digital camera automatically creates a directory of folders in the internal memory or on the memory card that it uses to organize still images, movie clips and other information.

Folder Structure

The folder name begins with a 3-digit number from 100 to 999 and is followed by "DCIM". A new folder can only be made manually. If new files are made, the new files named in sequence will be made automatically.



Naming Files

File names begin with "PICT" and are followed by a 4-digit number that increases in sequence. File numbering starts from 0001 when a new folder is created.

! Caution

- Do not change the folder and file names on the memory card using your computer: it may be unable to play back the data on the digital camera.

Troubleshooting

Problem	Cause	Solution
Power does not turn camera on.	Batteries are inserted in the wrong direction.	Reload batteries in the correct direction.
	Batteries are dead.	Replace or recharge batteries.
	The battery compartment door is open.	Make sure the battery compartment door is securely closed.
The camera does not take pictures.	The flash is charging.	Wait for the flash to charge.
	Memory is full.	Insert a new memory card.
	Memory card is not formatted correctly.	The card may be defective: use a new card.
Image is not recorded when the shutter button is pressed.	The flash is charging.	Wait for the flash to charge.
	Memory is full.	Insert a new memory card.
The flash does not fire.	Flash is set to OFF.	Set the flash to any mode except off.
The image is blurred or out of focus.	The camera was moving when the image was captured.	Hold the camera steady when shooting a picture.
The image is not displayed on the LCD monitor.	A memory card with non-PICT images (recorded with another camera) is loaded.	This camera cannot display non-PICT images.
Recorded images are not saved in memory.	The camera was turned off/powering down before saving images to the memory.	If the battery low indicator appears on the LCD monitor, replace the battery immediately.

Specifications

	AgfaPhoto sensor 505-D	AgfaPhoto sensor 510-D	AgfaPhoto sensor 500-D
Sensor	5 MegaPixel CMOS, Size: 1/2.5 inch	5 MegaPixel CMOS, Size: 1/2.5 inch	3 MegaPixel CMOS, Size: 1/2.5 inch
Display	2.4" TFT color LCD	2.4" TFT color LCD	2.0" TFT color LCD
Focus range	150cm ~ infinity	150cm ~ infinity	150cm ~ infinity
Aperture	F3.1, Fixed focus	F3.1, Fixed focus	F3.1, Fixed focus
Shutter	Electronic shutter: 1/2,000 ~ 1/14 sec.	Electronic shutter: 1/2,000 ~ 1/14 sec.	Electronic shutter: 1/2,000 ~ 1/14 sec.
File format	Still Image: JPEG (EXIF 2.2 compatible) Video: AVI Audio: WAV	Still Image: JPEG (EXIF 2.2 compatible) Video: AVI Audio: WAV	Still Image: JPEG (EXIF 2.2 compatible) Video: AVI Audio: WAV
Resolution	Still Image: 2592 x 1944; 2048 x 1536; 1600 x 1200; 1280 x 960; 640 x 480 Video: 640 x 480, 320 x 240	Still Image: 8 MP interpolation 3264 x 2448; 2592 x 1944; 2048 x 1536; 1600 x 1200; 640 x 480 Video: 640 x 480, 320 x 240	Still Image: 5 MP interpolation 2592 x 1944; 2048 x 1536; 1600 x 1200; 1280 x 960; 640 x 480 Video: 640 x 480, 320 x 240
Sensitivity	Auto	Auto	Auto
White balance	Auto, Daylight, Tungsten, Fluorescent, Cloudy	Auto, Daylight, Tungsten, Fluorescent, Cloudy	Auto, Daylight, Tungsten, Fluorescent, Cloudy
Exposure control	-2EV to +2EV in 1/3	-2EV to +2EV in 1/3	-2EV to +2EV in 1/3

	steps	steps	steps
Burst	Included	Included	Included
Flash	Auto, Always on, Always off	Auto, Always on, Always off	Auto, Always on, Always off
Photo effect	Color, Sepia, Monochrome	Color, Sepia, Monochrome	Color, Sepia, Monochrome
Selftimer	Disable / 10 / 20 sec.	Disable / 10 / 20 sec.	Disable / 10 / 20 sec.
Storage	32 MB internal memory External memory: SD (2 GB)	32 MB internal memory External memory: SD (2 GB)	32 MB internal memory External memory: SD (2 GB)
TV system	NTSC / PAL	NTSC / PAL	NTSC / PAL
Power supply	AAA rechargeable battery x 2 (optional); AAA alkaline battery x 2	AAA rechargeable battery x 2 (optional); AAA alkaline battery x 2	AAA rechargeable battery x 2 (optional); AAA alkaline battery x 2
Environmental temperature	Operating: 0° C to 40° C Storage: -20 to 60° C	Operating: 0° C to 40° C Storage: -20 to 60° C	Operating: 0° C to 40° C Storage: -20 to 60° C
Microphone	Built-in	Built-in	Built-in
Speaker	Not included	Not included	Not included
Dimension camera body (W x H x D):	100x 59.4 x 26.6mm	100x 59.4 x 26.6mm	100x 59.4 x 26.6mm
Weight (w/o battery)	Approx. 85 (g)	Approx. 85 (g)	Approx. 85 (g)

***These specifications are subject to change without prior notice.**

Customer care

More information on the complete AgfaPhoto digital camera product range can be found under www.plawa.com / www.plawausa.com

Service & Repair (USA / Canada):

1-866 475 2605

www.plawausa.com – live chat available

Support Service (USA / Canada):

support-apdc@plawausa.com

Online Service USA / Canada:

support-apdc@plawausa.com

Service & Repair Hotline (Europe):

00800 752 921 00 (from a landline only)

Service & Support Hotline (Germany):

0900 1000 042 (1.49 Euro/ min. from a German landline only)

Online Service / International contact (Not USA / Canada):

support-apdc@plawa.com

Designed and manufactured by

plawa-feinwerktechnik GmbH & Co. KG

Bleichereistraße 18

73066 Uhingen

Germany

AgfaPhoto is used under license of Agfa-Gevaert NV & Co. KG. Agfa-Gevaert NV & Co. KG. does not manufacture this product or provide any product warranty or support. For service, support and warranty information, contact the distributor or manufacturer. Contact: AgfaPhoto Holding GmbH, www.agfaphoto.com

Disposal of Waste Equipment by Users in Private Households in the European Union



This symbol on the product or on its packaging indicates that this product must not be disposed of with your other household waste. Instead, it is your responsibility to dispose of your waste equipment by handing it over to a designated collection point for the recycling of waste electrical and electronic equipment. The separate collection and recycling of your waste equipment at the time of disposal will help to conserve natural resources and ensure that it is recycled in a manner that protects human health and the environment. For more information about where you can drop off your waste equipment for recycling, please contact your local city office, your household waste disposal service or the shop where you purchased the product.

FCC Compliance and Advisory

This device complies with Part 15 of the FCC Rules. Operation is subject to the following two conditions: 1.) this device may not cause harmful interference, and 2.) this device must accept any interference received, including interference that may cause unsatisfactory operation. This equipment has been tested and found to comply with the limits for a Class B peripheral, pursuant to Part 15 of the FCC Rules. These limits are designed to provide reasonable protection against harmful interference in a residential installation. This equipment generates, uses, and can radiate radio frequency energy and, if not installed and used in accordance with the instructions, may cause harmful interference to radio communication. However, there is no guarantee that interference will not occur in a particular installation. If this equipment does cause harmful interference to radio or television reception, which can be determined by turning the equipment off and on, the user is encouraged to try to correct the interference by one or more of the following measures.

- Reorient or relocate the receiving antenna.
- Increase the separation between the equipment and receiver.
- Connect the equipment to an outlet on a circuit different from that to which the receiver is connected.
- Consult the dealer or an experienced radio/TV technician for help.

Any changes or modifications not expressly approved by the party responsible for compliance could void the user's authority to operate the equipment. When shielded interface cables have been provided with the product or when specified additional components or accessories have elsewhere been designated to be used with the installation of the product, they must be used in order to ensure compliance with FCC regulations.